

 Rainbow Aluminium Extrusion co. Plot No : 17,18,19,3 Sojitra,GIDC, Anand-Sojitra Road,
Dist : Anand, State : Gujarat-387240

 +91 98250 64053
+91 95863 73888
+91 91570 34990

 info@rainbawaluminiumextrusion.com
sales@rainbawaluminiumextrusion.com
Web :www.rainbawaluminiumextrusion.com



FLAT BAR

SECTION NO	THICKNESS	WEIGHT RANGE/12FT
4021	25X3	0.800/1.00
4019-2	25x5	1.200
4012-1	25x6	1.400
4010-1	30X3	0.900
4011-2	30X6	1.900
4011-1	30X8	2.300
4011	30X10	3.0/3.2
4010	35X3	1.1/1.3
4010-2	40X4	1.600
4015	40X6	2.4/2.6
4020	40X7	2.800
4012	40X10	4.0/4.2
4019-1	50X5	2.240
4013	50X10	5.0/5.2
4013-1	50X12	6.320
4014	60X10	6.0/6.2
4016-1	88X5	6.590
4017	88X6	5.0/5.2
4016	85X8	6.6/6.8
4019-3	100X5	4.80
4018	100X10	10.0/10.2

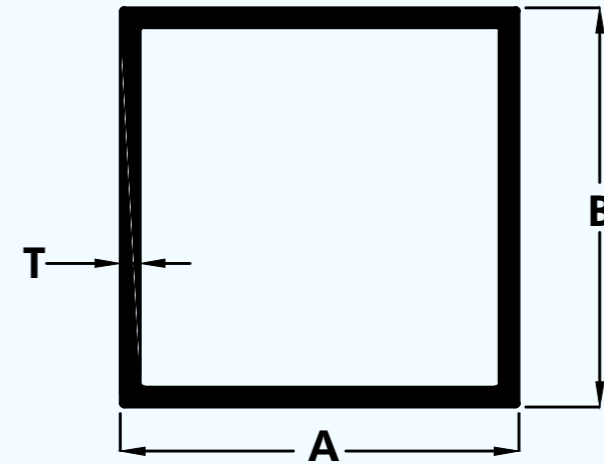

SECTION NO	A	B	T	WEIGHT\12FT
1121	31.00	31.00	1.2	1.400/1.600
1120	63.00	63.00	1.1	2.600/2.800
5001	38.00	38.00	1.2	1.700/1.900

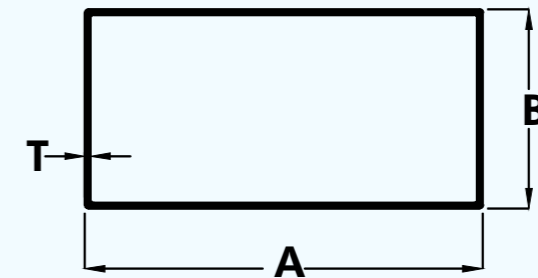

SECTION NO	A	B	T	WEIGHT\12FT
1128	33	20	0.90	0.800/1.000
1124	38	25	0.90	1.000/1.200
1124/1	38	25	2.00	2.300/2.600
1124/2	38	25	0.80	0.800/1.000
1129	50	20	0.80	1.100/1.300
1123	50	25	2.00	2.700/2.900
1123/1	50	25	0.95	1.200/1.400
1122/1	60	34	0.80	1.400/1.600
1122/2	63	38	0.75	1.400/1.600
1127	63	25	0.85	1.300/1.500
1122	63	38	1.50	3.000/3.200
1125	100	25	1.20	2.700/2.900
1126	125	25	1.15	3.400/3.600

EQUAL ANGLE

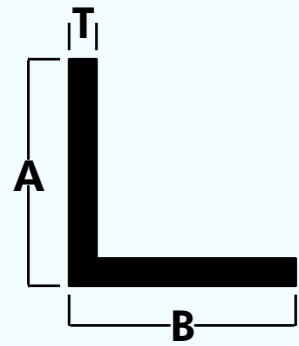

SECTION NO	A	B	T	WEIGHT\12FT
1354	25.00	25.00	1.50	0.900/1.100
1355	38.00	38.00	2.00	2.200/2.400
1353	19.00	19.00	1.50	0.700/0.900
1352-1	38.00	38.00	3.00	1.500/1.700

ROUND PIPE

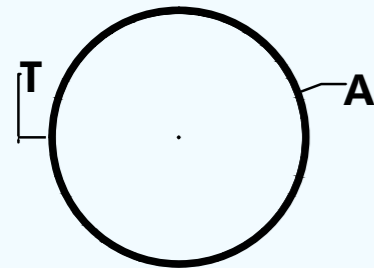

SECTION NO	A	B	T	WEIGHT\12FT
1230	30.00	28.60	0.70	0.600/0.800
R67	38.00	36.86	0.76	0.900/1.000

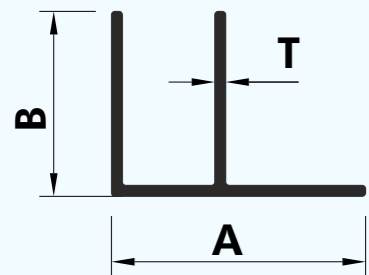

SECTION NO	A	B	T	WEIGHT\12FT
R63	22.00	16.00	1.00	0.500/0.600

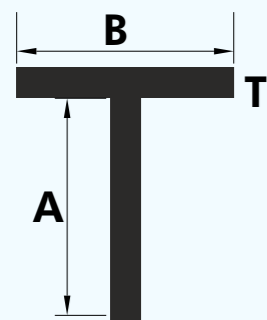

SECTION NO	A	B	T	WEIGHT\12FT
R61	25.00	25.00	1.00	0.500/0.600
R62	19.00	19.00	1.00	0.400/0.500

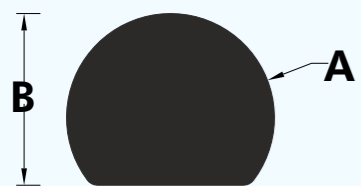

SECTION NO	A	B	T	WEIGHT\12FT
JD 01	16.00	13.20		1.800/2.000

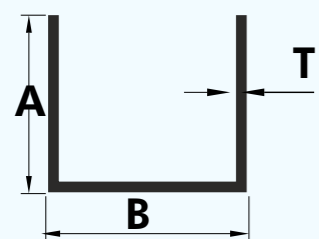

SECTION NO	A	B	T	WEIGHT\12FT
R 64	12.00	12.00	1.00	0.250/0.350
R 63	9.00	9.00	1.00	0.250/0.350
R 65	14.80	9.00	1.00	0.350/0.450

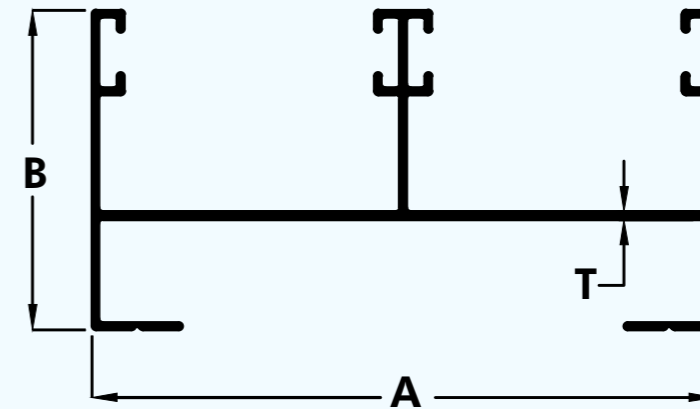

SECTION NO	A	B	T	WEIGHT\12FT
1204-5	61.50	31.50	0.75	1.1/1.3
1204/3	61.50	31.50	0.85	1.5/1.7
1204/4	61.50	31.50	0.90	1.6/1.8
1204-1	61.50	31.50	1.00	2.1/2.3
1204-2	61.50	31.50	1.20	2.4/2.6
1204	61.50	31.50	1.50	2.8/3.0
1" 1001	75.00	25.40	1.10	1.8/2.0

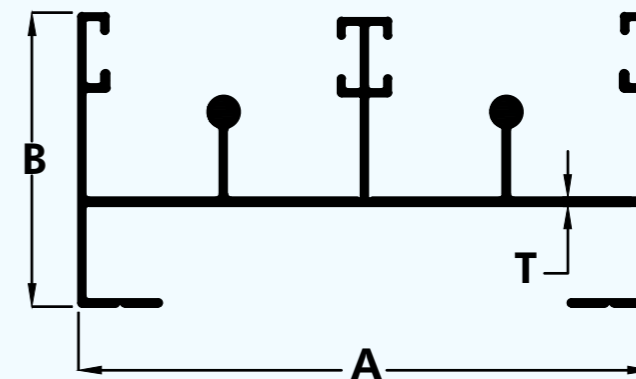

SECTION NO	A	B	T	WEIGHT\12FT
1205-2	61.50	31.50	1.00	2.2/2.4
1205-1	61.50	31.50	1.20	2.8/3.0
1205	61.50	31.50	1.50	3.2/3.4
1205/3	61.50	31.50	1.00	1.8/2.0
1205/4	61.50	31.50	0.85	1.7/1.8
1205/5	61.50	31.50	0.85	1.5/1.7
1" 1002	75.00	25.40	1.10	2.2/2.4

THREE TRACK TOP

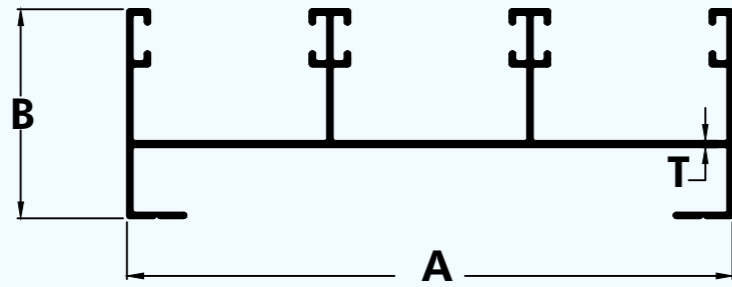

SECTION NO	A	B	T	WEIGHT\12FT
1206-5	92.00	31.75	0.75	1.400/1.600
1206	92.00	31.75	0.85	1.900/2.100
1206-4	92.00	31.75	1.50	2.600/2.800
1206-2	92.00	31.75	1.20	3.200/3.000
1206-3	92.00	31.75	1.50	3.800/4.000
1274	122.40	31.75	1.20	3.800/4.000
1" 1003	116.00	25.40	1.10	2.500/2.700

THREE TRACK BOTTOM

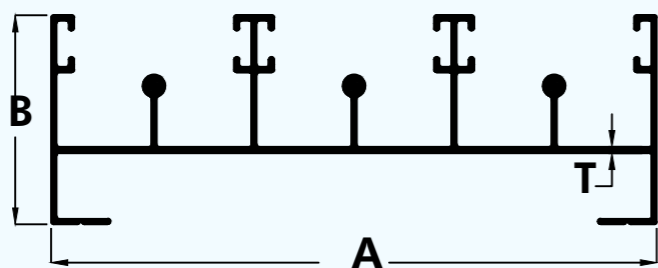

SECTION NO	A	B	T	WEIGHT\12FT
1207	92.00	31.75	0.95	2.500/2.700
1207-1	92.00	31.75	1.10	3.000/3.200
1207-2	92.00	31.75	1.20	3.600/3.800
1207-3	92.00	31.75	1.50	4.200/4.400
1275	122.40	31.75	1.15	4.000/4.200
1207/4	92.00	31.75	0.75	2.200/2.400
1" 1004	116.00	25.40	1.10	3.200/3.400

HANDLE

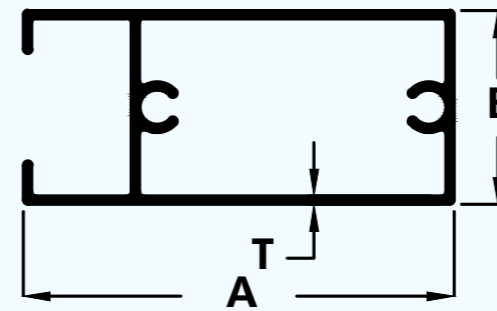

SECTION NO	A	B	T	WEIGHT\12FT
1210-5	40.00	18.00	0.70	0.800/1.00
1210-4	40.00	18.00	0.80	1.100/1.300
1210	40.00	18.00	1.00	1.300/1.500
1210-3	40.00	18.00	1.00	1.400/1.600
1210-1	40.00	18.00	1.20	1.600/1.800
1210-2	40.00	18.00	1.50	2.000/2.200
1211-2	50.00	25.00	1.00	1.600/1.800
1211	50.00	25.00	1.20	2.100/2.300
1211-1	50.00	25.00	1.50	2.600/2.800
1211-3	50.00	25.00	1.00	1.400/1.600
1360	75.00	25.00	1.00	2.200/2.400
1211-4	50.00	25.00	0.80	1.200/1.400

TOP BOTTOM

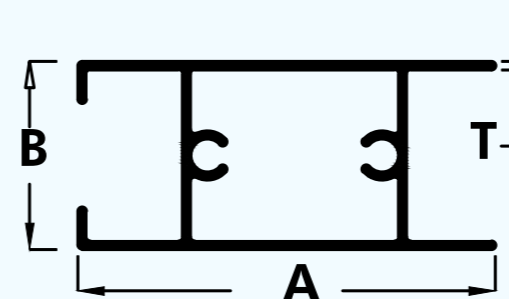

SECTION NO	A	B	T	WEIGHT\12FT
1216-4	40.00	18.00	0.80	1.000/1.200
1216-3	40.00	18.00	0.95	1.300/1.500
1216	40.00	18.00	1.00	1.300/1.500
1216-1	40.00	18.00	1.30	1.600/1.800
1216-2	40.00	18.00	1.50	2.000/2.300
1216-3	52.00	18.00	1.10	1.300/1.400
1214	50.00	25.00	1.10	1.700/1.900

INTERLOCK

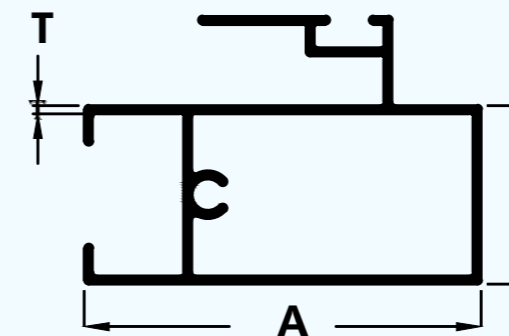

SECTION NO	A	B	T	WEIGHT\12FT
1212-4	40.00	18.00	0.80	1.100/1.300
1212-1	40.00	18.00	0.95	1.400/1.600
1212-3	40.00	18.00	1.40	2.000/2.200
1212-2	40.00	18.00	1.50	2.200/2.400
1213	50.00	25.00	1.00	2.000/2.200
1268	60.00	18.00	1.00	1.900/2.200

SINGLE PARTITION

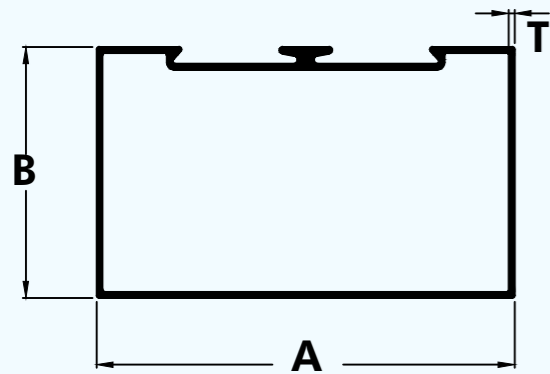

SECTION NO	A	B	T	WEIGHT\12FT
1133-5	63.50	38.10	0.75	1.500/1.700
1133	63.50	38.10	0.75	1.600/1.800
1133-4	63.50	38.10	0.85	1.800/2.000
1133-1	63.50	38.10	1.50	3.200/3.300
1133-3	63.50	38.10	1.10	2.200/2.400
1133-2	63.50	38.10	1.60	3.200/3.500
1134	101.00	44.00	3.00	8.700/8.900
1134-1	101.00	44.00	1.00	3.300/3.500
1131	50.80	25.40	1.20	1.800/1.900

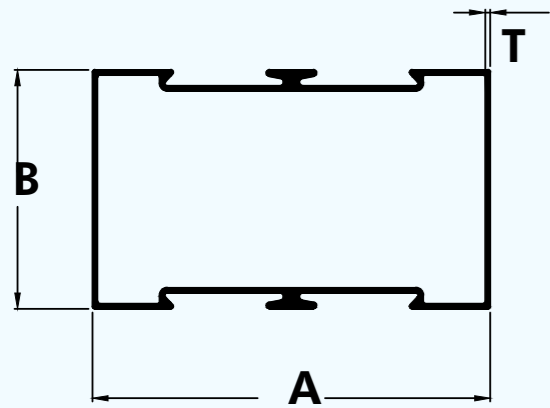

DOUBLE PARTITION

SECTION NO	A	B	T	WEIGHT\12FT
1132-1	63.50	38.10	0.80	1.900/2.100
1132-2	63.50	38.10	1.20	2.700/2.800
1132-3	63.50	38.10	1.50	3.200/3.300
1135	101.00	44.00	3.00	9.000/9.200
1135-1	101.00	44.00	1.00	3.600/3.700
1132-4	63.50	38.10	1.50	3.200/3.500

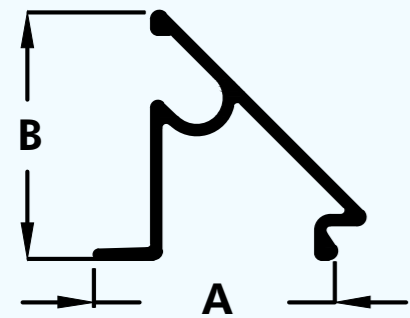

GLAZING CLIP

SECTION NO	A	B	T	WEIGHT\12FT
1254	19.00	17.30	0.80	0.370/0.390
1254-1	19.00	17.30	0.70	2.500/3.00

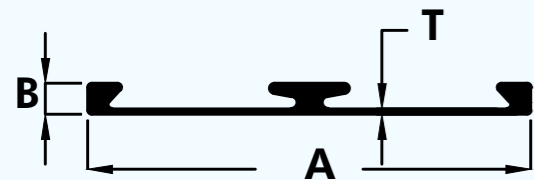

GLAZING PATTÀ

SECTION NO	A	B	T	WEIGHT\12FT
1112-1	44.45	3.10	0.56	0.550/0.650

L TUBE DOOR FRAME

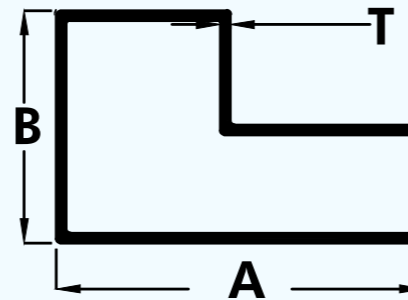

SECTION NO	A	B	T	WEIGHT\12FT
1250-2	38.00	24.00	0.75	0.900/1.100
1250-1	38.00	24.00	1.00	1.000/1.200
1250	38.00	24.00	1.2	1.400/1.600

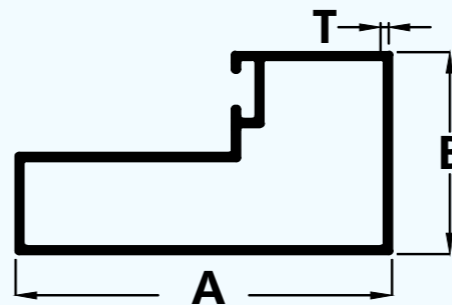

SECTION NO	A	B	T	WEIGHT\12FT
1251-1	38.00	24.00	0.90	1.400/1.600
1251	45.00	24.00	1.20	1.700/1.900

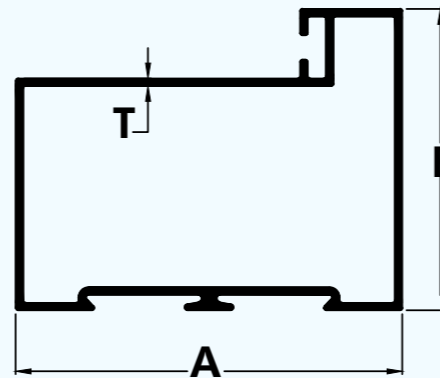

LEG SINGLE PARTITION

SECTION NO	A	B	T	WEIGHT\12FT
1252-1	63.50	49.50	0.90	2.400/2.600
1252	63.50	49.50	1.50	3.900/4.200

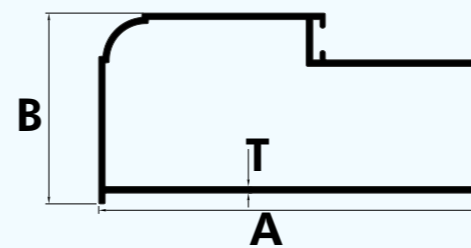

SECTION NO	A	B	T	WEIGHT\12FT
1254	108.00	53.00	1.80	5.6/5.7

DOOR VERTICAL 45MM

SECTION NO	A	B	T	WEIGHT\12FT
1243	47.62	44.45	1.10	2.300/2.500

DOOR TOP 45MM

SECTION NO	A	B	T	WEIGHT\12FT
1241	47.62	44.45	1.10	2.2/2.4

DOOR MIDDLE DOUBLE 45MM

SECTION NO	A	B	T	WEIGHT\12FT
1240	44.45	47.62	1.10	2.200/2.400

DOOR MIDDLE SINGLE

SECTION NO	A	B	T	WEIGHT\12FT
1242	47.62	44.45	1.10	2.200/2.400

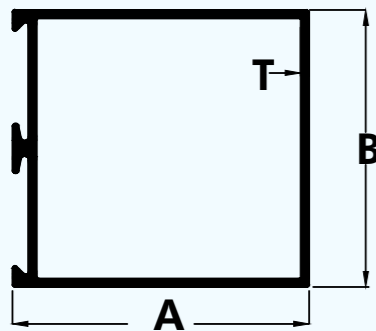
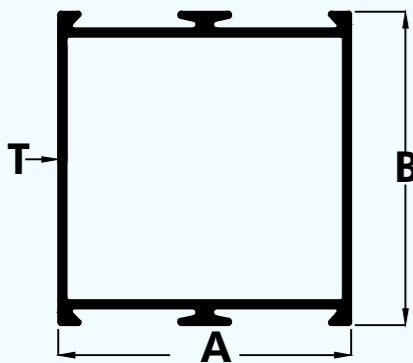
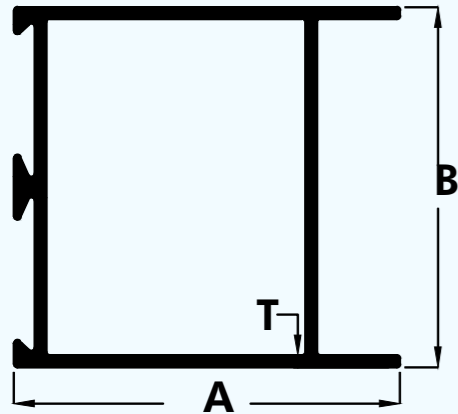
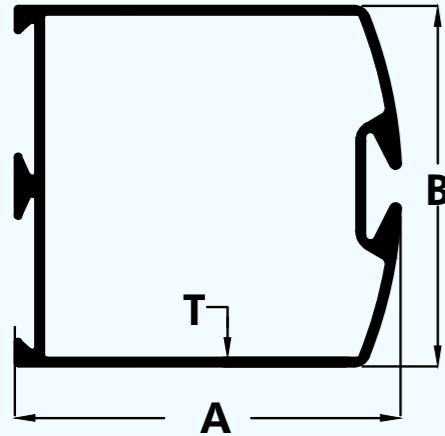

DOOR VERTICAL 85MM

SECTION NO	A	B	T	WEIGHT\12FT
1270	85.00	44.45	1.30	3.500/3.800

DOOR TOP 85MM

SECTION NO	A	B	T	WEIGHT\12FT
1273	85.00	44.45	1.20	3.800/3.900

DOOR MIDDLE DOUBLE 85MM

SECTION NO	A	B	T	WEIGHT\12FT
1271	85.00	44.45	1.15	3.800/3.900

DOOR BOTTOM

SECTION NO	A	B	T	WEIGHT\12FT
1260 small leg	114.00	44.45	1.20	4.400/4.600
1261	114.00	44.45	1.20	4.400/4.600

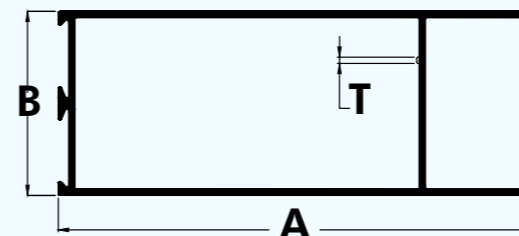
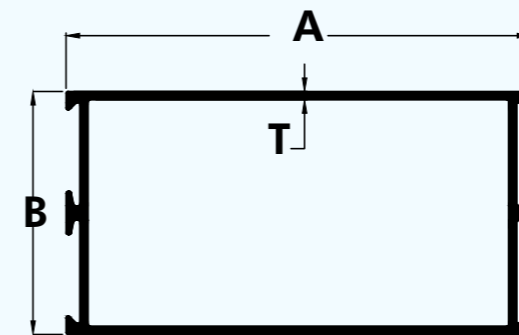
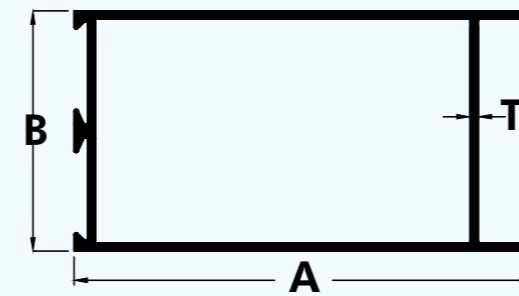
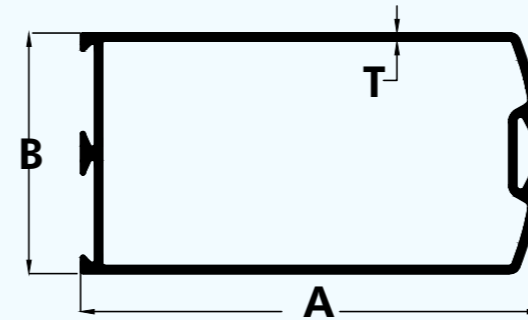

HANDLE 60X18MM

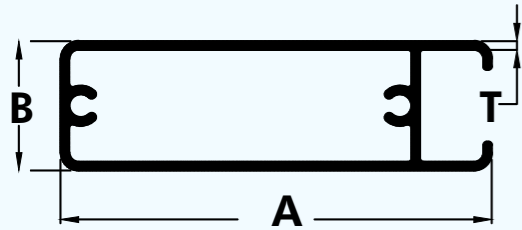

SECTION NO	A	B	T	WEIGHT\12FT
1267-1	60.00	18.00	1.00	1.60/1.80
1267-2	60.00	18.00	1.25	2.30/2.50

INTERLOCK 60 X 108MM

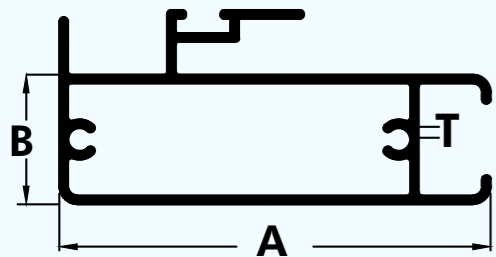

SECTION NO	A	B	T	WEIGHT\12FT
1268-1	60.00	18.00	1.00	2.000/2.200
1268-2	60.00	18.00	0.90	1.900/2.000

BEARING BOTTOM 60 X18MM

SECTION NO - RAEC1269

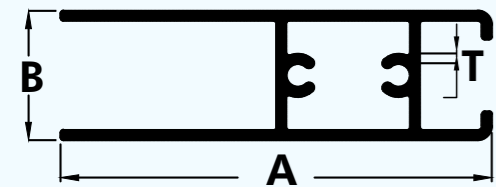

SECTION NO	A	B	T	WEIGHT\12FT
1269-1	60.00	18.00	1.00	1.500/1.700
1269	60.00	18.00	1.25	2.400/2.600

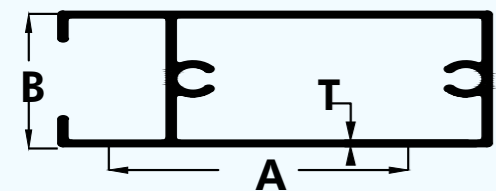

SECTION NO	A	B	T	WEIGHT\12FT
1210-6	75.00	18.00	1.00	1.500/1.700

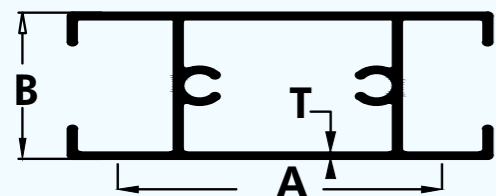

SECTION NO	A	B	T	WEIGHT\12FT
1215-2	75.00	18.00	1.00	1.50/1.70

MOLDING HANDLE

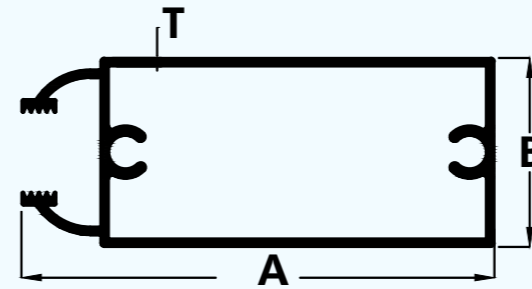

SECTION NO	A	B	T	WEIGHT\12FT
1218	60.00	25.00	0.95	1.900/2.100

MOLDING MIDDLE

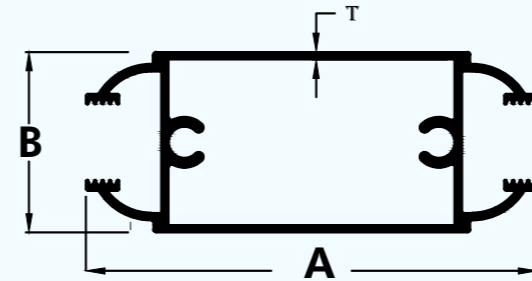

SECTION NO	A	B	T	WEIGHT\12FT
1219	60.00	25.00	0.95	2.000/2.200

MOLDING L TUBE

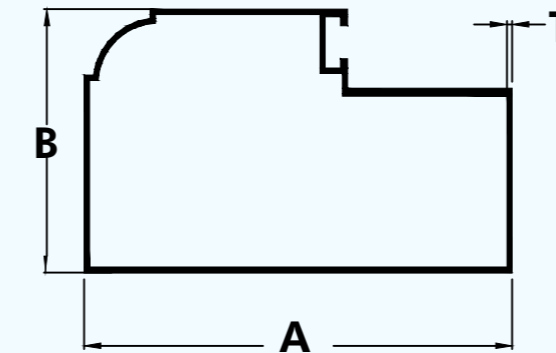

SECTION NO	A	B	T	WEIGHT\12FT
1253	65.00	40.00	1.10	2.100/2.300

MIDDLE

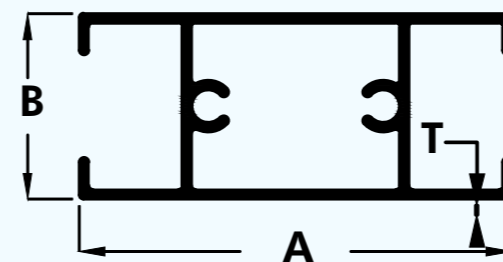

SECTION NO	A	B	T	WEIGHT\12FT
1215-1	40.00	18.00	0.80	1.000/1.200
1214-1	40.00	18.00	1.00	1.600/1.800
1361	75.00	25.00	0.90	2.300/2.500

SECTION NO - RAEC DH

THREE TRACK

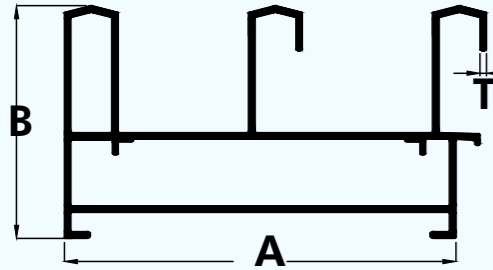

SECTION NO	A	B	T	WEIGHT\12FT
301	75.41	44.80	1.50	4.800/5.000
301-1	75.41	44.80	1.20	4.100/4.300
301-2	75.41	44.80	1.15	3.400/3.600

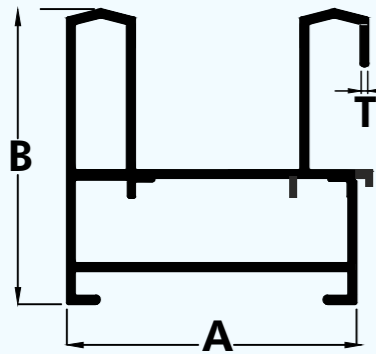

SECTION NO	A	B	T	WEIGHT\12FT
300	45.00	45.00	1.10	2.600/2.800

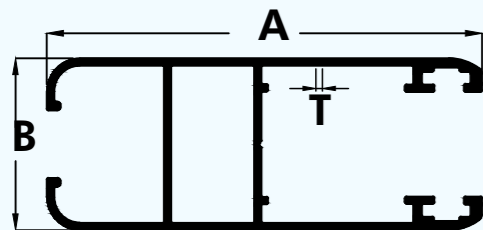

SECTION NO	A	B	T	WEIGHT\12FT
302	66.10	26.14	1.40	2.800/3.000
302-2	66.10	26.14	1.30	2.700/3.900

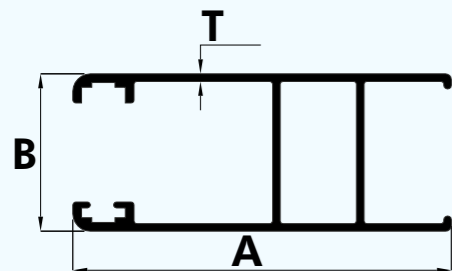

SECTION NO	A	B	T	WEIGHT\12FT
303	65	27	1.3	2.700/2.900

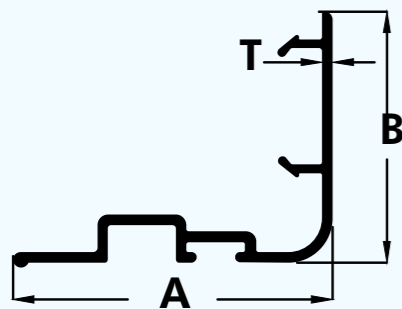

SECTION NO	A	B	T	WEIGHT\12FT
303	66.10	26.14	1.00	0.900/1.100

KITCHEN FRAME 45MM

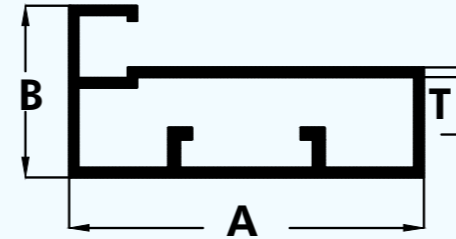

SECTION NO	A	B	T	WEIGHT\12FT
1265	44.20	21.40	1.20	1.600/1.700

KITCHEN FRAME 65MM

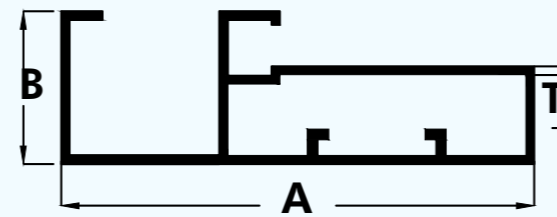

SECTION NO - RAEC1266

SECTION NO	A	B	T	WEIGHT\12FT
1266	66.40	21.40	1.21	1.800/1.900

G PROFILE

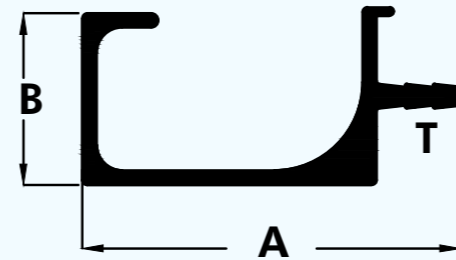

SECTION NO	A	B	T	WEIGHT\12FT
1103	45.00	20.40	1.50	1.200/1.300

FURNITURE TRACK

PROFILE TRACK

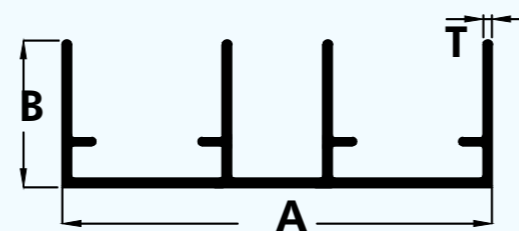

SECTION NO	A	B	T	WEIGHT\12FT
1105	58.50	20.00	1.20	2.100/2.200
1105-1	58.50	20.00	0.80	1.800/1.900

SECTION NO - RAEC1106

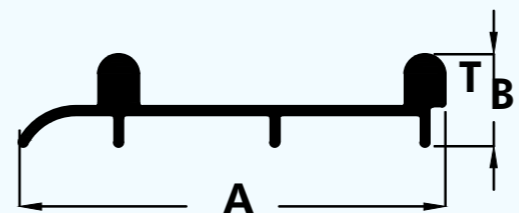

SECTION NO	A	B	T	WEIGHT\12FT
1106	49.06	10.60	1.20	1.40/1.50

22MM FOLDING SLIDING SERIES

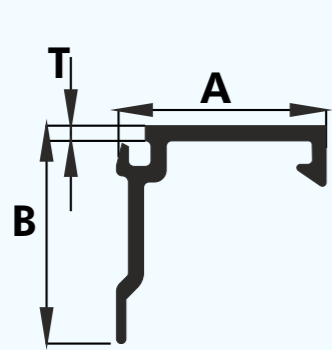

SECTION NO	A	B	T	WEIGHT\12FT
3301	17.9	18.60	1.30	0.550/0.600

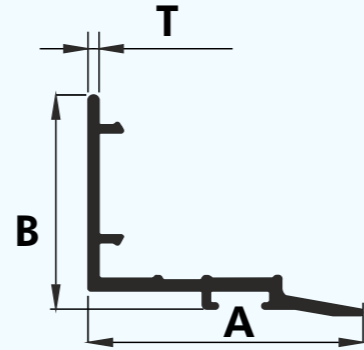

SECTION NO	A	B	T	WEIGHT\12FT
3302	34.07	26.49	1.35	0.930/1.000

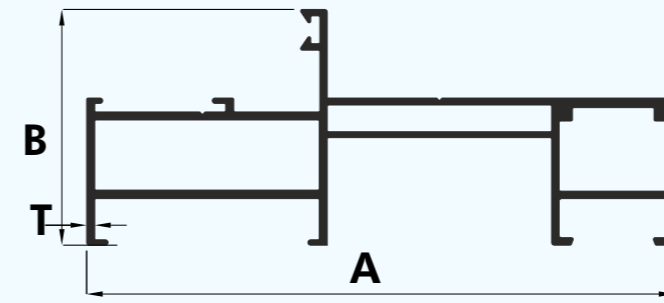

SECTION NO	A	B	T	WEIGHT\12FT
5002	110.00	44.05	1.50	5.100/5.300

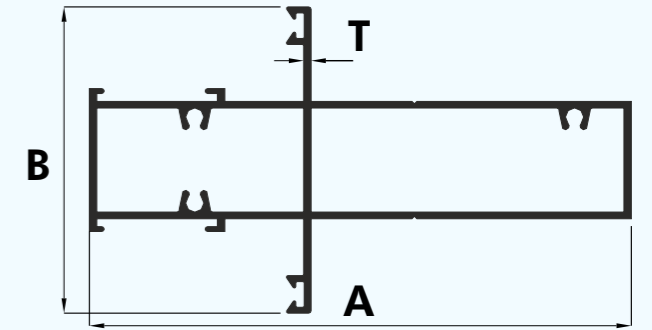

SECTION NO	A	B	T	WEIGHT\12FT
5004	110.00	62.10	1.50	5.300/5.400

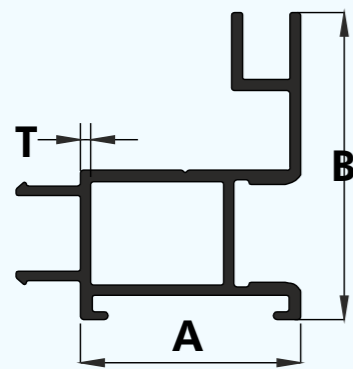

SECTION NO	A	B	T	WEIGHT\12FT
3303	28.00	39.00	1.30	1.950/2.100

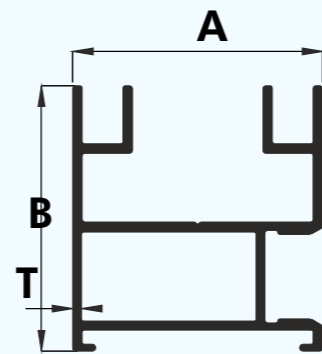

SECTION NO	A	B	T	WEIGHT\12FT
3304	34.07	26.49	1.35	0.930/1.00

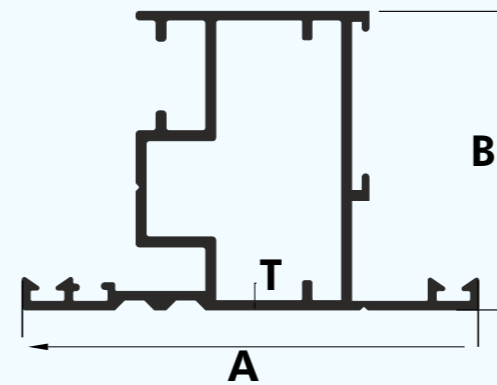

SECTION NO	A	B	T	WEIGHT\12FT
5003	68.81	45.00	1.40	3.500/3.700

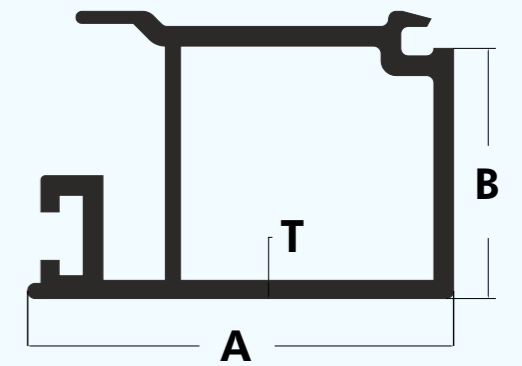

SECTION NO	A	B	T	WEIGHT\12FT
5006	28.20	16.55	1.20	1.200/1.300

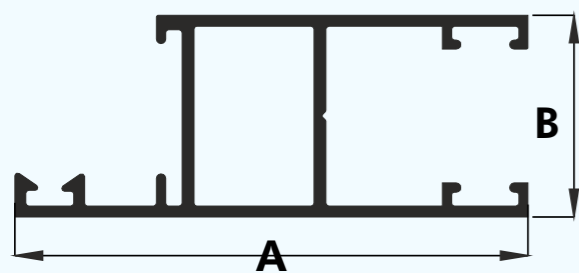

SECTION NO	A	B	T	WEIGHT\12FT
5007	56.00	22.00	1.32	1.950/2.100

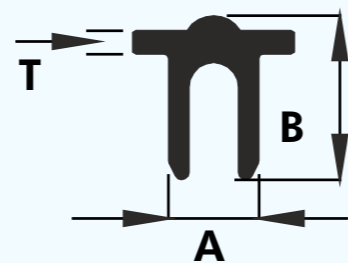

SECTION NO	A	B	T	WEIGHT\12FT
3306	6.10	11.06	1.59	0.450/0.600

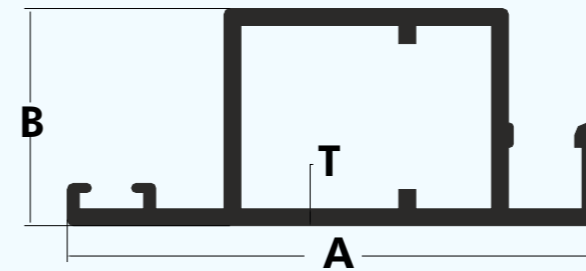

SECTION NO	A	B	T	WEIGHT\12FT
5005	45.00	20.00	1.40	3.500/3.700

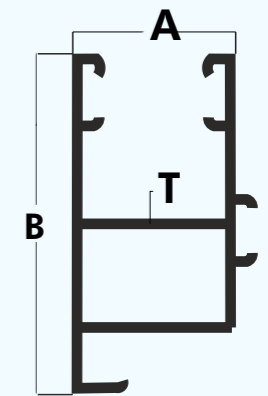

SECTION NO	A	B	T	WEIGHT\12FT
3305	22.00	45.00	1.20	1.800/2.300

40MM OPENABEL SERIES

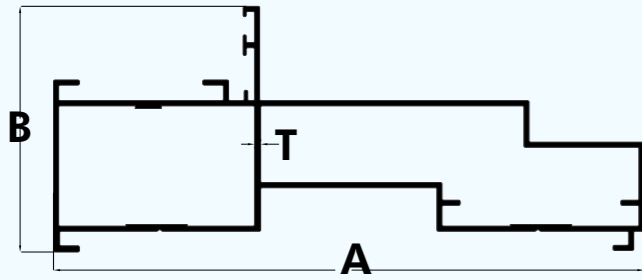

SECTION NO	A	B	T	WEIGHT\12FT
R57	114.00	47.40	1.20	3.776/3.900

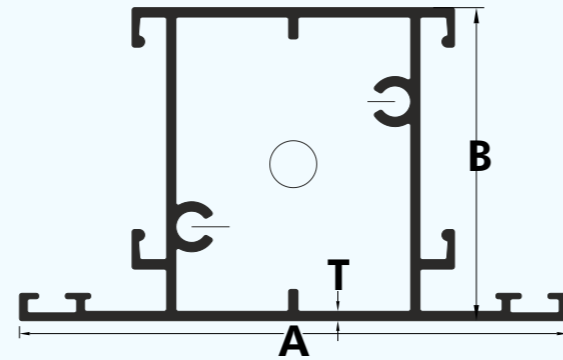

SECTION NO	A	B	T	WEIGHT\12FT
r56	70.00	40.00	1.20	2.884/3.00

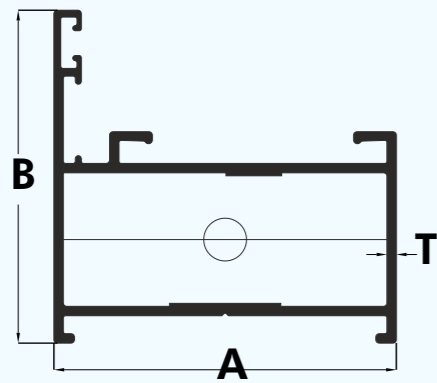

SECTION NO	A	B	T	WEIGHT\12FT
R58	40.00	38.90	1.10	1.800/1.900

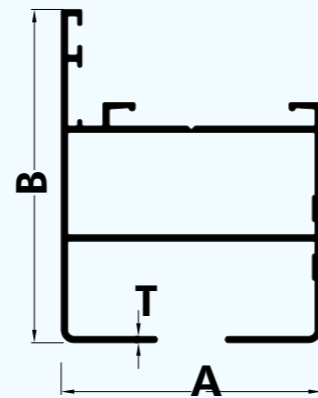

SECTION NO	A	B	T	WEIGHT\12FT
R55	40.00	51.20	1.00	2.100/2.200

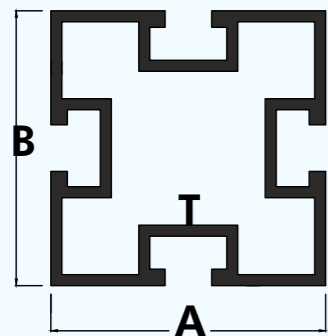

SECTION NO	A	B	T	WEIGHT\12FT
gp01	50.00	50.00	2.00	5.900/6.100

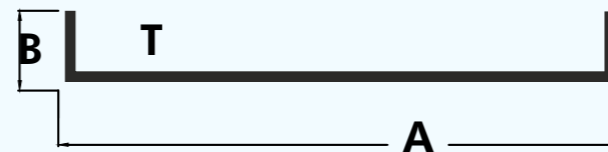

SECTION NO	A	B	T	WEIGHT\12FT
1348	50.00	8.00	1.10	0.900/1.100

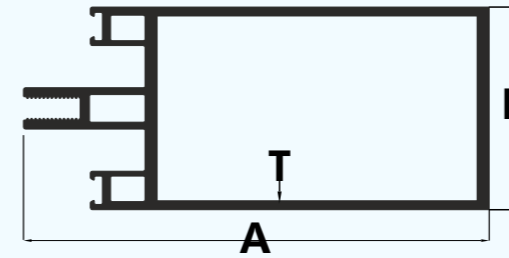

SECTION NO	A	B	T	WEIGHT\12FT
1350	115.00	50.00	2.20	8.500/8.700

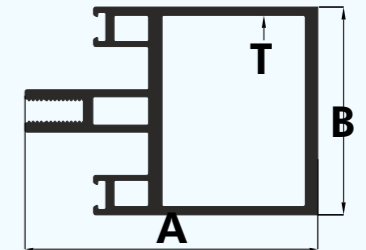

SECTION NO	A	B	T	WEIGHT\12FT
1351	70.50	50.00	2.00	6.700/6.900

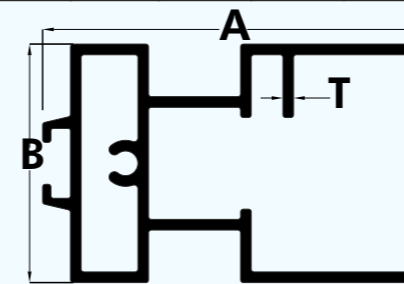

SECTION NO	A	B	T	WEIGHT\12FT
1501-3	41.00	25.70	1.20	1.800/2.000

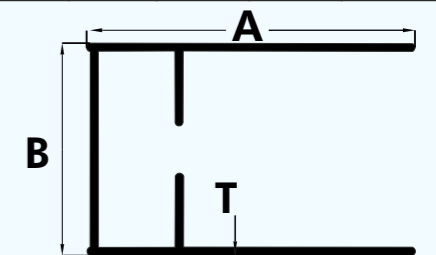

SECTION NO	A	B	T	WEIGHT\12FT
1501-1	45.00	29.00	1.10	1.400/1.600

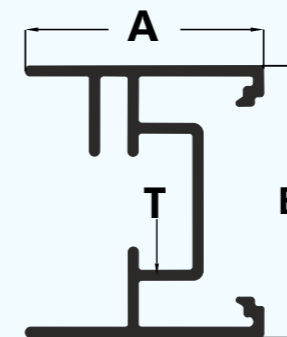

SECTION NO	A	B	T	WEIGHT\12FT
1501-4	25.50	25.5	1.10	1.500/1.700

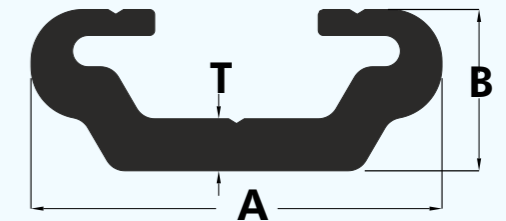

SECTION NO	A	B	T	WEIGHT\12FT
P01	39.50	15.50	5.00	2.800/3.000
P01-1	39.50	15.50	5.00	2.800/3.000

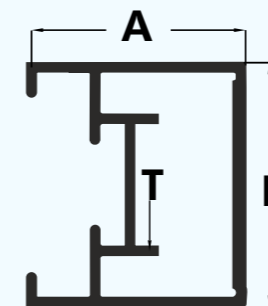

SECTION NO	A	B	T	WEIGHT\12FT
1501-2	25.50	25.50	1.10	1.500/1.700

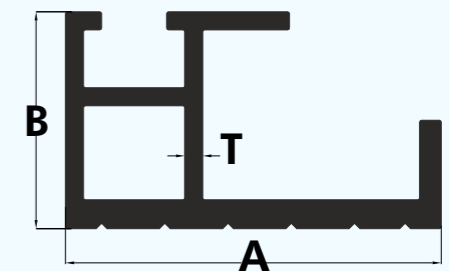

SECTION NO	A	B	T	WEIGHT\12FT
P02	52.00	30.00	2.50	5.100/5.300

SOLAR FRAME

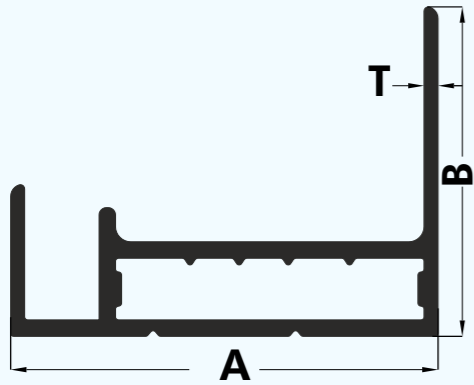

SECTION NO	A	B	T	WEIGHT\12FT
S01	35.00	27.00	1.15	1.400/1.500

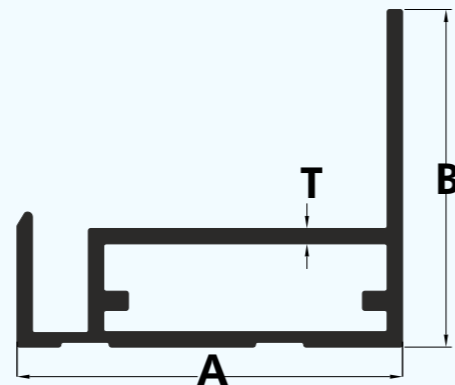

SECTION NO	A	B	T	WEIGHT\12FT
S02	40.00	35.00	1.60	2.00/2.100

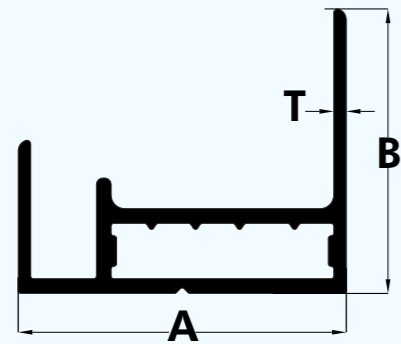

SECTION NO	A	B	T	WEIGHT\12FT
S03	30.00	26.00	1.15	1.250/1.350

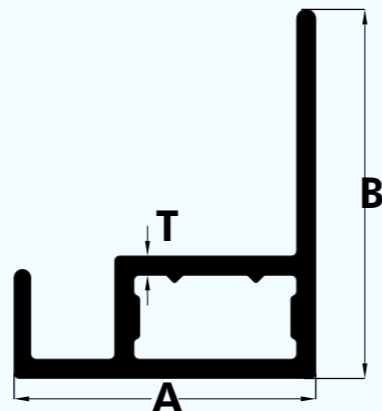

SECTION NO	A	B	T	WEIGHT\12FT
S04	18.00	22.00	1.20	0.800/0.900

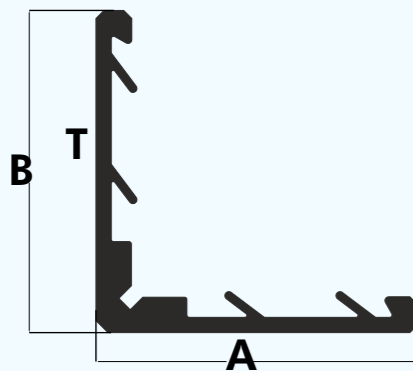

SECTION NO	A	B	T	WEIGHT\12FT
S05	40.00	40.00	1.90	2.200/2.300

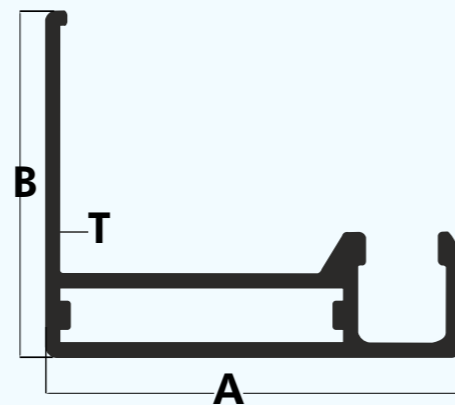

SECTION NO	A	B	T	WEIGHT\12FT
1401-17	30.00	25.00	1.00	1.00/1.100

SOLAR INDUSTRY STRUCTURE

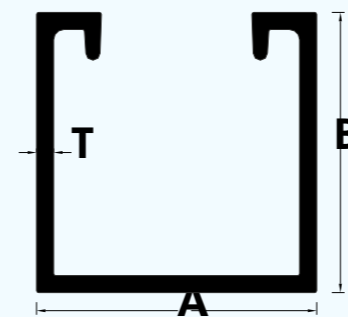

SECTION NO	A	B	T	WEIGHT\12FT
Se 01	41.00	41.00	2.80	3.650/3.850
Se 05	41.00	41.00	2.50	3.400/3.600
1349	41.00	26.00	3.00	3.200/3.400
1349-1	41.00	26.00	2.50	2.550/2.750

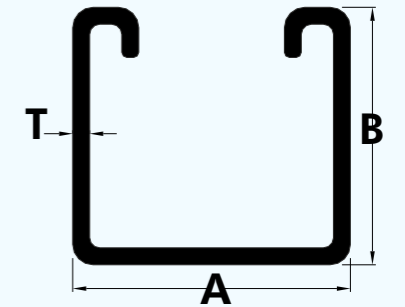

SECTION NO	A	B	T	WEIGHT\12FT
1349-2	41.00	38.00	3.00	3.900/4.100
1349-4	41.00	38.00	2.60	3.200/3.400
1401-9	41.00	38.00	2.50	3.100/3.300

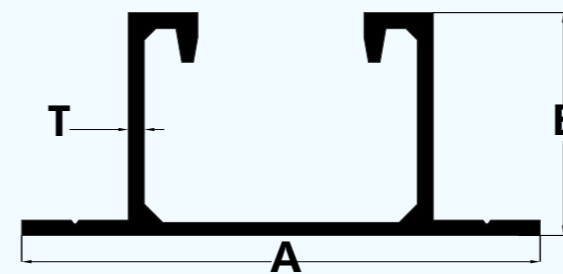

SECTION NO	A	B	T	WEIGHT\12FT
1401	68.00	29.2	2.1	2.900/3.100
Sc 03	68.00	29.2	2.1	2.900/3.100

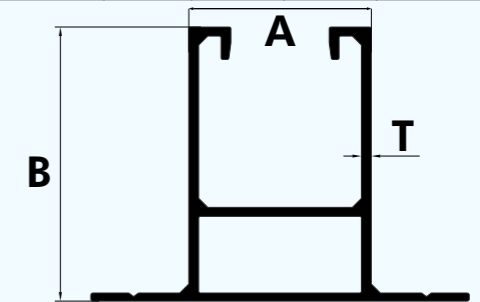

SECTION NO	A	B	T	WEIGHT\12FT
SE 04	41.00	61.00	2.50	5.300/5.500
SE 06				4.700/4.900

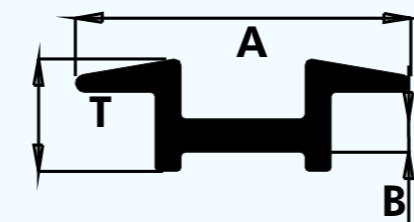

SECTION NO	A	B	T	WEIGHT\12FT
SE 02	38.00	12.80	3.80	1.700/1.900
3308	38.00	12.80	3.80	1.700/1.900

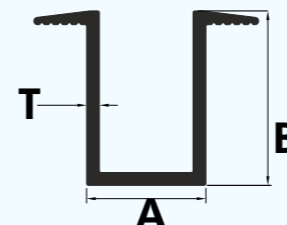

SECTION NO	A	B	T	WEIGHT\12FT
5008	26.00	38.00	2.8	3.200/3.400

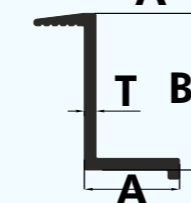

SECTION NO	A	B	T	WEIGHT\12FT
3307	23.00	38.00	3.00	1.900/2.100
3307-1	23.00	38.00	2.80	1.900/2.100
3307-2	23.00	40.00	2.80	2.00/2.200

20MM SLIDING SERIES

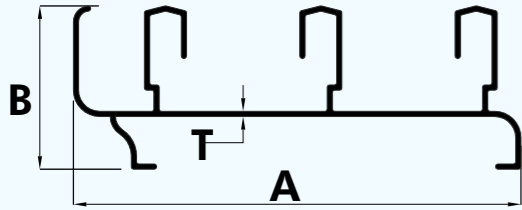

SECTION NO	A	B	T	WEIGHT\12FT
D51	85.85	31.31	1.00	2.400/2.500

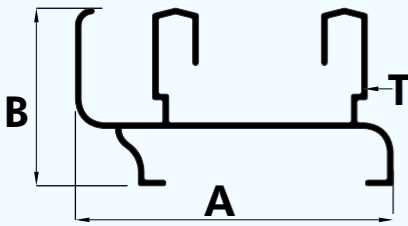

SECTION NO	A	B	T	WEIGHT\12FT
D52	56.06	31.31	1.00	1.700/1.900

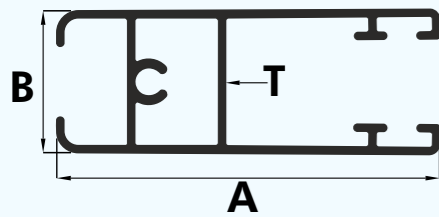

SECTION NO	A	B	T	WEIGHT\12FT
D54	54.55	20.20	1.00	1.800/1.900

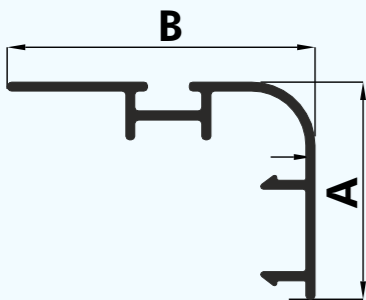

SECTION NO	A	B	T	WEIGHT\12FT
D53	24.24	34.34	1.00	0.770/0.900
zDc3	24.24	34.34	1.00	0.770/0.900